



**ANALYTICAL AND THEORETICAL STUDIES OF THE  
ASPIRATION AND FRACTIONATION PROCESS OF LOCAL  
SOYBEAN SEEDS**

**S.K. Kuzibekov, N.R. Barakaev, A.O. Uzaydullaev**

Gulistan State University

Gulistan, Uzbekistan

---

**Abstrakt.** The most important condition for obtaining high-quality soybeans is strict compliance with the technological requirements for each individual operation. Compliance with these requirements is possible only with the organization of on-farm quality control of soybeans during post-harvest processing. One of the ways to intensify the soybean aspiration process is the use of a grate with inclined holes in the aspiration zone and a selected fan to carry out the purification process from light and heavy impurities.

**Key words:** Technological process of aspiration, power, reliability, gas dynamics, hydrodynamics, aspiration, compressible liquids, mathematical models, physical models.

---

The most important condition for obtaining high-quality soybeans is strict compliance with the technological requirements for each individual operation. Compliance with these requirements is possible only with the organization of on-farm quality control of soybeans during post-harvest processing.

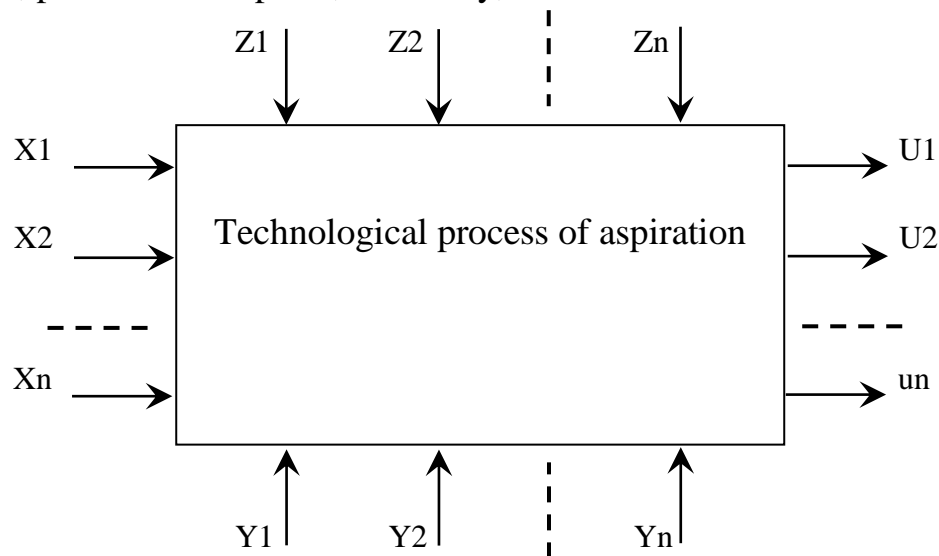
One of the ways to intensify the soybean aspiration process is the use of a sieve with inclined holes in the aspiration zone and a selected fan for the purification process from light and heavy impurities.

The theoretical study of the ongoing phenomena, namely the technological process, is presented as an object of research, which is characterized by input and output parameters [1; 27-38c, 2; 5-14c.].

The technological process of aspiration and separation of soy mixture on shelves as an object of research can be presented in the form of a block diagram [1; 27-38c, 2; 5-14c, etc.] (Fig.1).

The group of parameters Y, Z are input and X, U are output indicators characterizing the aspiration process. In relation to the combined separator, these

will be productivity, purification from light and heavy impurities, completeness of separation, power consumption, reliability, etc.



**Fig. 1. Flowchart of the technological process.**

The group of parameters  $Z$  characterizes the properties of the soy mixture entering the shaking shelves: the composition of the soy mixture, size, configuration, humidity, particle mass, feed, etc.

The group of parameters  $Y$  characterizes the design parameters of the aspiration part of the separator. These include: the dimensions and material of the shaking shelves, the shapes and sizes of the holes, the shape and dimensions of the jumpers, the suction speed of the fan, the angles of installation of the shaking shelves, etc.

Parameter group  $X, U$  corresponding incoming and outgoing parameters: (weight, weediness, fan suction rate, etc.).

The task of theoretical research is to establish patterns of relationships between the input and output parameters of the object.

If the input effects on the object do not change in time and space and the output parameters are also unchanged, then the process is called stationary. If at least one input effect changes in time or space, then the process of corresponding change in the output parameters of the object is called dynamic, at the end of the transition time it becomes stationary [1; 27-38c.].

For the theoretical study of static and dynamic characteristics of the object, a mathematical model of the technological process is compiled.

In general, a variety of models of hydrodynamics and gas dynamics are used to simulate the movement of a gas medium in aerosol mechanics. Aspiration problems are relevant for particles of sufficiently large sizes, which

are characterized by small values of the Knudsen number, therefore, the gas around them can be described in the framework of continuum mechanics. The models of potential and viscous incompressible fluid flow are used below: for velocities typical for most sampling tasks, without a noticeable loss of accuracy, where the compressibility of the gas medium can be neglected.

Within the framework of the axisymmetric potential flow model of the carrier medium, a boundary value problem is posed for the current function satisfying the Laplace equation in cylindrical coordinates. The solution of the corresponding boundary value problem is found by the boundary element method. As is known, the essence of this method consists in converting a partial differential equation describing the behavior of an unknown function inside and on the boundary of the domain into an integral equation that determines only the boundary values. In the usual formulation, the unknown function is represented as an integral along the boundary on which sources and sinks are distributed. In this paper, the method of discrete vortices is used when concentrated vortices are distributed at the boundary. The value of the current function at the inner points of the region is determined through a known solution at the boundary obtained from the integral equation. Since all approximations due to numerical calculations are related only to the boundary, the dimension of the problem is reduced by one.

In the framework of the viscous laminar gas flow model, the carrier medium is described by the Navier-Stokes equations

$$\begin{aligned} \frac{\partial p}{\partial t} + \nabla \cdot (p\bar{u}) &= 0, \\ \frac{\partial}{\partial t}(p\bar{u}) + \nabla \cdot (p\bar{u}\bar{u}) &= -\nabla p + \nabla \cdot (\bar{\tau}) + p\bar{g} + \bar{F} \end{aligned} \quad (1)$$

The first equation in (1) is a mass conservation equation and is suitable for both incompressible and compressible liquids. The second equation is the equation of conservation of the amount of motion,  $p$  - is the static pressure,  $(\bar{\tau})$  - is the stress tensor,  $p\bar{g}$  and  $\bar{F}$  - are the gravitational and external mass (arising, for example, due to interaction with the dispersed phase) forces, respectively. The stress tensor  $(\bar{\tau})$  is given by the formula

$$(\bar{\tau}) = \mu [ (\nabla\bar{u} + \nabla\bar{u}^T) - \frac{2}{3} \nabla \cdot \bar{u} I ], \quad (2)$$

where  $\mu$  - is the coefficient of dynamic viscosity,  $I$  - is the unit tensor. The second term in the right part characterizes the effects of volumetric expansion.

The equations of conservation of the amount of motion have a similar structure and can be written as a general transfer equation of an arbitrary characteristic  $\phi$ :

$$\frac{\partial p\phi}{\partial t} + \nabla \cdot (p\phi\bar{u}) = \nabla \cdot (\Gamma\nabla\phi), \quad (3)$$

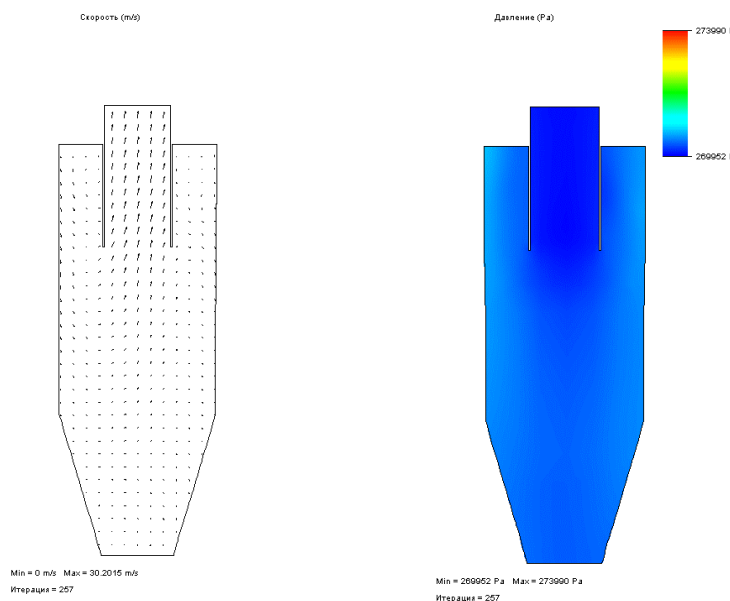
where  $\Gamma$  - is the diffusion coefficient of the characteristic  $\phi$ .

To transform equation (4) into a system of linear algebraic equations, we use the finite volume method. This method is based on the integration of equation (4) over a certain control volume  $V$ :

$$\int_V \frac{\partial(p\phi)}{\partial t} dV + \oint p\phi\bar{u} \cdot d\bar{A} = \oint \Gamma\nabla\phi \cdot d\bar{A}, \quad (4)$$

where  $A$  is a vector directed along the normal to the surface of volume  $V$ . During integration, volume integrals are transformed into surface integrals, according to the Ostrogradsky-Gauss theorem. Equation (4) expresses the law of conservation of characteristic  $\phi$  for the control volume  $V$ . This equation is compiled for each cell of the computational domain. Then a discretization is performed, leading to a system of linear algebraic equations. The resulting system is solved numerically by the Gauss-Seidel method.

Currently, physical and mathematical models and numerical methods of modern computational fluid dynamics have found their embodiment in a number of software packages united by the common name SolidWorks. The convenience of work and the capabilities of SolidWorks significantly expand the range of tasks to be solved in the field of fluid mechanics. One of the widely used SolidWorks is the Flow Simulation package. In Fig.2. the developed computer model of the soybean purification process from impurities by the Flow Simulation package is shown.



**Fig. 2. Computer model of soybean purification process from impurities**

As noted, the main task of the theory of sampling of aerosol particles is to calculate the aspiration coefficient - the integral characteristic of the sampler.

At the same time, for a better understanding of the aspiration process, it is important to know the spatial distribution of the particle concentration in the vicinity and inside the sampler. The need to calculate the particle concentration also arises when determining the aspiration coefficient in the case of heterogeneity in the distribution of concentration or velocity of aerosol particles in a medium not disturbed by the sampler, as well as in non-stationary problems.

The main factors affecting the efficiency of the aspiration process are: the specific mass load of soy on the suction channel of the aspiration unit  $q$ , the air flow velocity  $v_B$  and the width of the pneumatic separation channel  $B$ .

When modeling the operation parameters of a diametral fan in the SolidWorks system, the purpose of the calculation is to determine its aerodynamic properties for a given geometric parameters.

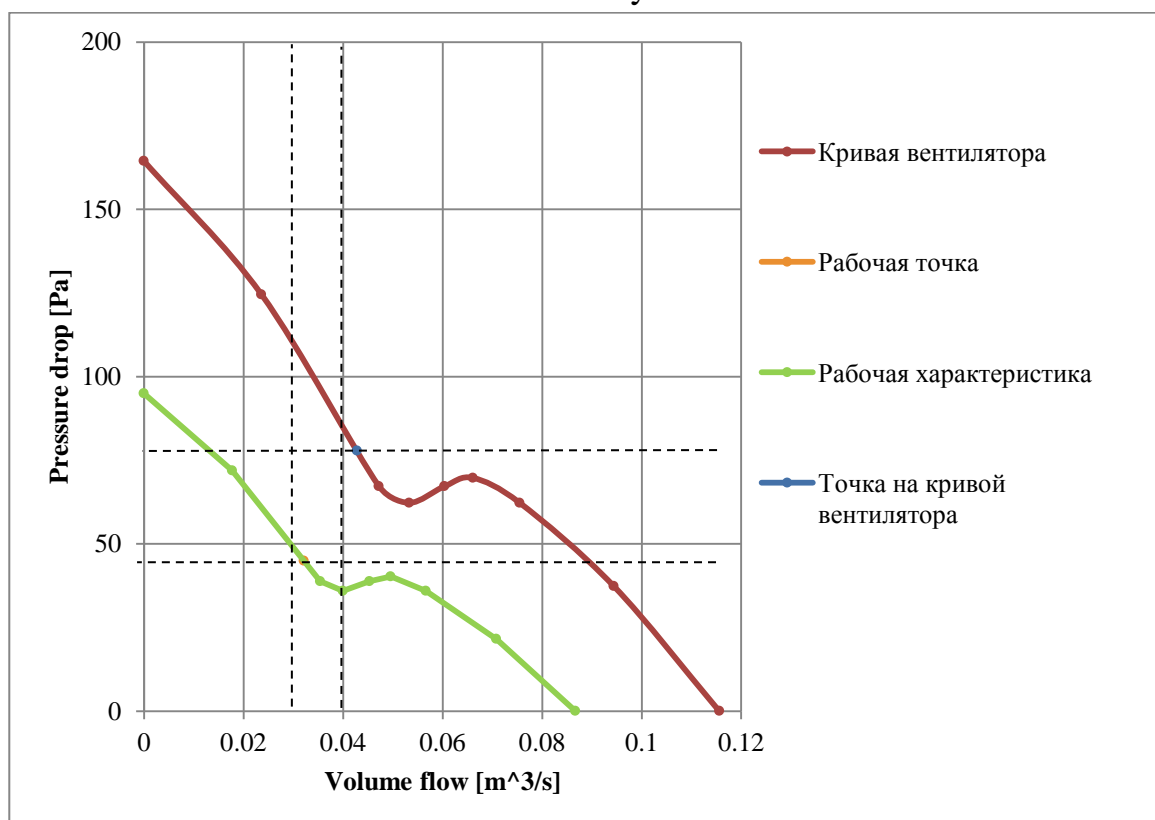
At the initial stage of modeling, a volumetric model of a diametral fan with real dimensions is created in the SolidWorks three-dimensional modeling system. Then the resulting model is transferred to the Flow Simulation system for aerodynamic analysis.

The study of the aerodynamic parameters of the diametral fan was carried out with the following parameters: the width of the fan impeller was assumed to be  $B = 0.1$  m; the speed of the fan impeller  $n = 1000$  rpm; fan performance in operating mode  $Q_v = 0.3$  m<sup>3</sup>/s.

Using the Flow Simulation SAE system, the dependences of the pressure drop on the volumetric flow rate are obtained (Fig. 3.) of the fan. To do this, a series of calculations of the fan model was performed, changing its performance in the range  $Q_v = 0.3 \text{ m}^3/\text{s}$ .

As can be seen from the graph (Fig. 3.), the simulated fan provides stable aerodynamic parameters over the entire operating range.

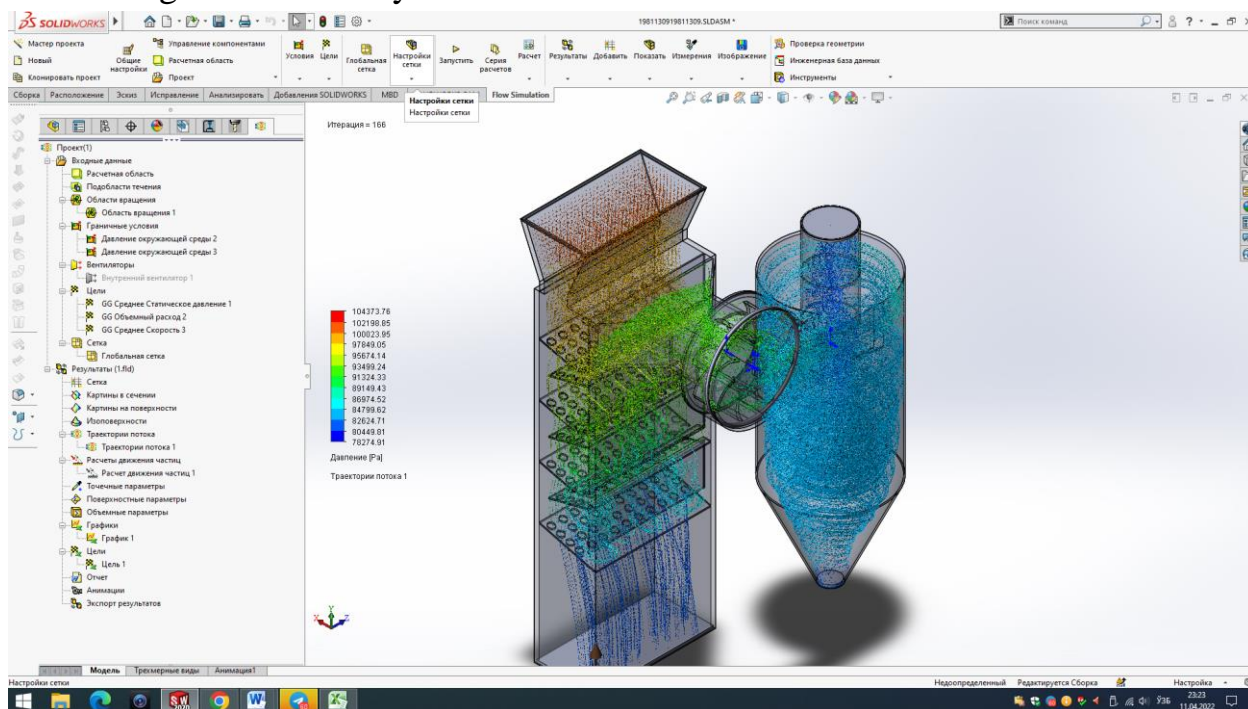
To study the parameters of the operation of the air system of the combined aspiration unit, a volumetric model was created in the SolidWorks three-dimensional modeling system with real dimensions in one projection, the width of the model was taken at  $B = 0.1 \text{ m}$ . The aerodynamic analysis of this model was further carried out in the Flow Simulation system.



**Fig. 3. Curves of the pressure drop dependence on the volume flow of the fan**

To study and compare the parameters of the airflow flow inside the air system with experimental data, a sketch was created in the frontal plane of the model, on which a route is laid in the fairway of the airflow from the inlet section to the outlet section (Fig.4.). On the three-dimensional model of the air system of the aspiration installation, it is indicated:  $P$  - is the absolute pressure at the reference point, adjusted for the results of the experimental study;  $Q$  - is the

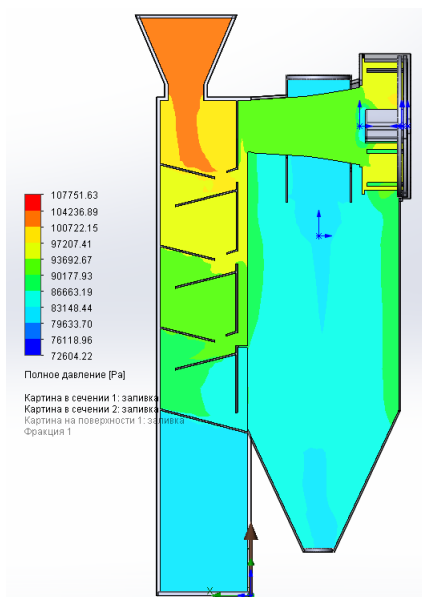
amount of air circulating inside the closed system in operating mode;  $Q_A$  - is the air taken into the aspiration nozzle;  $q$  - is the specific grain load, shown at the point of product entry into the suction channel of the aspiration unit, and the route along the the fairway of the air flow.



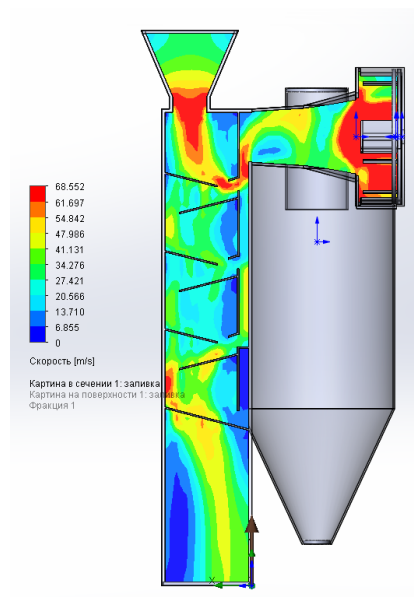
**Fig. 4. Three-dimensional model of the aspiration and fractionation process of local soybean seeds**

During the simulation, the following initial parameters were set:  $P=101370$  Pa,  $Q=0.1$  m<sup>3</sup>/s. During the calculations, the influence of gravity was also taken into account.

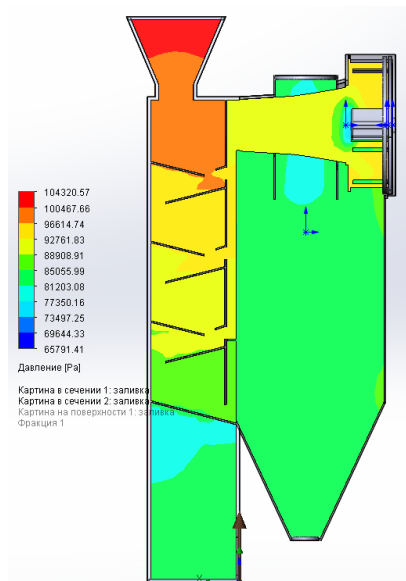
The advantage of computer modeling should be considered that the model allows you to quickly introduce constructive or technological changes into it and track changes in the physical parameters of the machine. Fig. 5. shows the field of distribution of the total pressure, and Fig. 8. shows the air flow lines. In this case, the color of the lines characterizes the change of the parameter in magnitude. The pressure difference between the input and output sections was  $\Delta P = 180$  Pa.



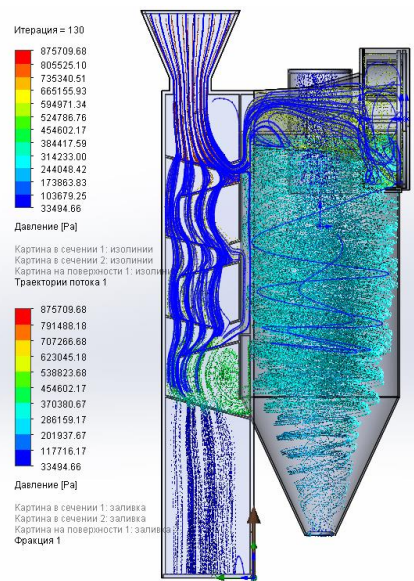
**Fig. 5. Total pressure distribution field in a closed air system**



**Fig. 6. Air velocity distribution field in a closed air system**



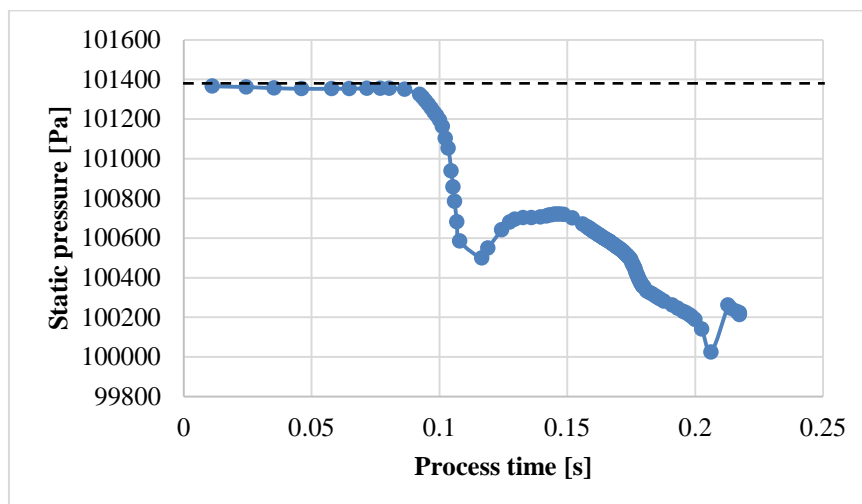
**Fig. 7. Static pressure distribution field in a closed air system**



**Fig. 8. Air flow lines in a closed air system**

The operability of the grain cleaning machine being developed can be judged by the obtained graph of the distribution of static pressures along the fairway of the air flow, shown in Fig. 9.





**Fig. 9. A graph of the distribution of static pressures  $P_s$  over the time of the air flow**

On the ordinate axis, the values of static pressure  $P_s$  are indicated on the graph, and on the abscissa axis, the length of the air flow path.

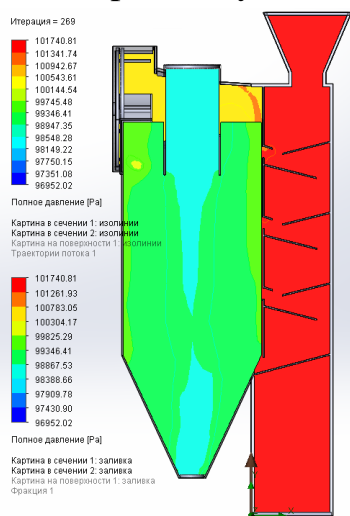
As can be seen from the graph (Fig. 9.), the static pressure line in the area of the aspiration zone is below the atmospheric pressure line, which makes it possible to exclude the possibility of dusty air being released into the working chamber, but it is necessary to reduce the static pressure to completely eliminate this possibility.

Thus, the next stage of the study was the calculation of a model in which 10% of the air is taken from the recirculation channel. Based on the law of conservation of mass, in order not to disrupt the balance of aerodynamic parameters inside the air system, we will take a 10% gap in the aspiration channel as the place of air intake into the system.

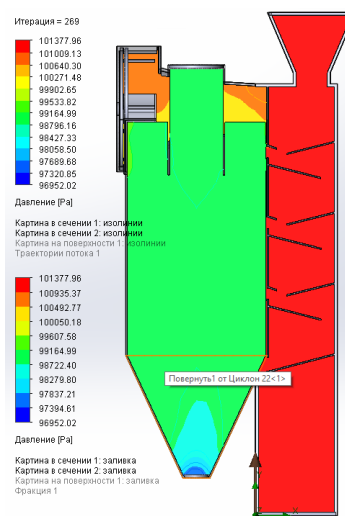
It is also advisable to conduct a simulation, allowing leaks in the pipes for the output of soybeans and ratios, taking the size of suction and leaks, respectively, for 5% of the air circulating inside the system. Taking into account the above assumptions, the research will be carried out with the following parameters:  $P=101370$  Pa,  $Q=0.1$  m/s,  $Q_A = 0.01$  m/s, air suction through the feed slot 0.01 m/s, as well as suction in the outlet for the output of  $0.005$  m<sup>3</sup>/s and leakage through the outlet for the output of soybeans  $0.005$  m<sup>3</sup>/s.

Fig. 10. shows the field of distribution of total pressure, Fig. 11. the field of distribution of air velocities in the frontal plane of an open air system, Fig. 12. the static pressure distribution field is shown, and Fig. 13. the air flow lines are shown. In this case, the color of the lines characterizes the change of the parameter in magnitude.

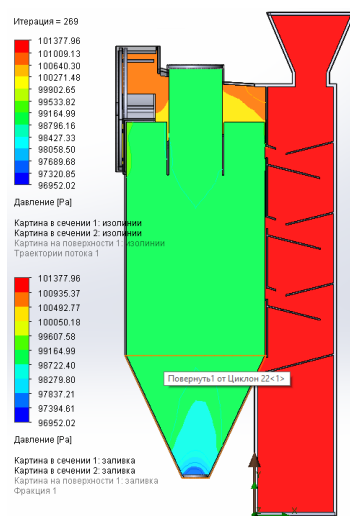
The pressure difference between the inlet and outlet sections was  $\Delta P=149$  Pa. A graph of the distribution of static pressures along the fairway of the air flow with an open air system is shown in Fig. 14.



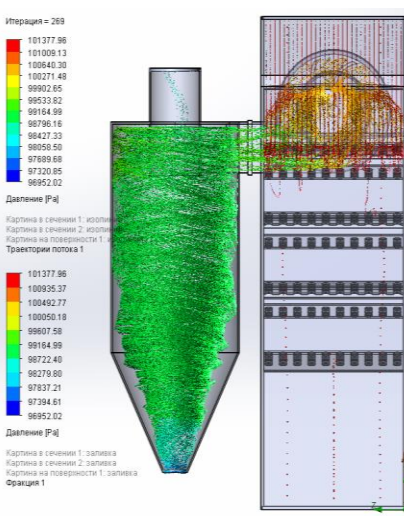
**Fig. 10.** The field of distribution of total pressure in a closed air system



**Fig. 11.** The field of distribution of air velocities in a closed air system

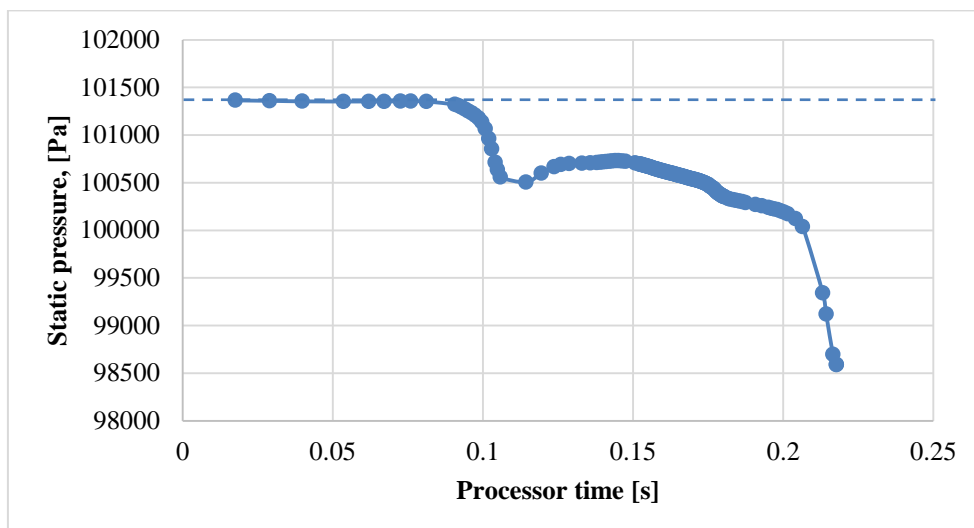


**Fig. 12.** Static pressure distribution field in a closed air system



**Fig. 13.** Air flow lines in a closed air system

The presented model particles are shown in the velocity field of the air flow (Fig. 11.), while the color of the lines corresponds to the velocity of the particles in this section of the trajectory. The trajectories of various fractions of model particles are shown (Fig. 13.), while the trajectories of blue color correspond to the main product - soybean grain, green - medium-natural relative, and red - light-natural relative.



**Fig. 14.** A graph of the distribution of static pressures  $P_s$  over the time of the air flow

The values of static pressure  $P_s$  are indicated on the ordinate axis on the graph, and the length of the air flow path is indicated on the abscissa axis. As can be seen from the graph (Fig. 14.), the static pressure line is below the atmospheric pressure line, which makes it possible to completely exclude the possibility of the release of dusty air into the working chamber. It should be noted that this result was obtained with the initial parameters of the conditional fan operation the same as in conditions with full aerodynamic tightness of the model. The paper shows that the practical characteristics of the fan depend on the conditions, the tightness of the nozzles, and, consequently, on the tightness conditions of the recirculation channel.

Based on the conducted analytical and theoretical studies, the following conclusions can be drawn:

On the basis of which a computer model of the aspiration and fractionation process of local soybean seeds was obtained. Graphical images were obtained showing the characteristics of the installation, curves of the pressure drop dependence on the volume flow of the fan, curves of the distribution of static pressures  $P_s$  over the time of the air flow. The concept of the relative velocity of hovering  $\vartheta$  is also introduced, as the difference between the absolute velocity  $\vartheta$  of a particle and the average velocity of the air flow  $U$ .

## Literature

1. Зильбернагель А.В. Интенсификация процесса сепарации зерна на плоских решетках с продолговатыми отверстиями, расположенными под углом. Дис...канд. техн. наук. Омск, 2005,- 172 с.
2. Лурье А.Б. О модели процесса сепарирования зерновых смесей и других сыпучих материалов на плоских решетках / Л.Б. Лурье, С.Л. Яновский // Зап. / Ленингр. с.-х. ин-т. - Л., 1974. - Т. 231. - С. 5-14.
3. Баракаев Н.Р. Создание технологических машин для сепарирования и фракционирования зерновых культур: Автореф. дис. . доктор. техн. наук. - Ташкент, 2016. - 82 с.
4. Раджабов А.Н. Маҳаллий дон навларини тозалаш ва фракциялаш технологиясини ишлаб чиқиш ва уларни синфлаш: т.ф.ф.д. ((PhD) дисс. Автореферати.-Ташкент, 2021.-44 б.
5. Barakaev N.R., Rajabov A.N., Akramov A., Berdiev A.A. Technological principles of increasing the productivity of a combined separator. // Bulletin of Gulistan State University 2017, No. 1, Pp. 49-55.
6. Barakaev N.R., Rajabov A.N. Separator of bulk product // Registered in the state register for utility model patent No. GAR 01243 of the Republic of Uzbekistan in Tashkent on 27.09.2017.
7. Barakaev N.R., Rajabov A.N., Bakhadirov G.A. Scientific basis for the creation of an experimental-test sample of a combination separator. // Composition materials. Scientific-technical and practical Journal. 2018. №1. 57-59 p.
8. Barakaev N.R., Kuzibekov S.K. Nutritional value when using soy for food purposes. // Composition materials. Scientific-technical and practical Journal. 2018. №1. 33-35 p.
9. Barakaev N.R., Kuzibekov S.K. The effect of primary cleansing on the quality of soybean oil. // Composition materials. Scientific-technical and practical Journal. 2018. №1. 112-115 p.
10. Barakaev N.R., Rizaev A.A., Bakhadirov G.A., Akramov A.A. Determination of forces acting on a particle in the receiving chamber of a combined separator when cleaning grain from light impurities. // Problems of mechanics. -2012. No.4. –Pp. 29-33.
11. Barakaev N.R., Berdiev O. Rajabov A.N. Grain cleaning and fractionation in a combined separator for obtaining high-quality feed flour. //

Proceeding of the regional Central Asian international conference on chemical technology. –Moscow, 2012. –P. 393-395.

12. Barakaev N.R., Rajabov A.N., Kurbanov M.T., Kuzibekov S.K. Improvement of the design of mobile equipment for post-harvest processing of agricultural crops. // Journal of Critical Reviews. ISSN- 2394-5125 Vol 7, Issue 14, 2020.

13. Бабич А.А. Соя - культура XXI века // Вестник науки: Сельское хозяйство, 2010.

14. Rasulov, A., Madjitova, J., & Islomova, D. (2022). PRINCIPLES OF TOURISM DEVELOPMENT IN DOWNSTREAM ZARAFSHAN DISTRICT. *American Journal Of Social Sciences And Humanity Research*, 2(05), 11-16.

15. Rasulov, A. B., Hasanov, E. M., & Khayruddinova, Z. R. STATE OF ENT ORGANS OF ELDERLY AND SENILE PEOPLE AS AN EXAMPLE OF JIZZAKH REGION OF UZBEKISTAN. ЎЗБЕКИСТОН РЕСПУБЛИКАСИ ОТОРИНОЛАРИНГОЛОГЛАРНИНГ IY СЪЕЗДИГА БАҒИШЛАНГАН МАҲСУС СОҢ, 22.

16. Расулов, А. Б., & Расулова, Н. А. (2013). Опыт периодизации географических взглядов. *Молодой ученый*, (7), 121-123.

17. Nigmatov, A. N., Abdireimov, S. J., Rasulov, A., & Beakaeva, M. E. (2021). Experience of using GIS technology in the development of geocological maps. *International Journal of Engineering Research and Technology*, 13(12), 4835-4838.

18. Matnazarov, A. R., Safarov, U. K., & Hasanova, N. N. (2021). THE STATE OF INTERNATIONAL RELATIONSHIP BETWEEN THE FORMATION AND ACTIVITY OF MOUNTAIN GLACIES OF UZBEKISTAN. *CURRENT RESEARCH JOURNAL OF PEDAGOGICS*, 2(12), 22-25.

19. Saparov, K., Rasulov, A., & Nizamov, A. (2021). Making geographical names conditions and reasons. *World Bulletin of Social Sciences*, 4(11), 95-99.

20. РАСУЛОВ, А. Б., & АБДУЛЛАЕВА, Д. Н. (2020). ПЕДАГОГИЧЕСКИЕ И ПСИХОЛОГИЧЕСКИЕ АСПЕКТЫ РАЗВИТИЯ НАВЫКОВ ИСПОЛЬЗОВАНИЯ САЙТОВ ИНТЕРНЕТА В ПРОЦЕССЕ ПОВЫШЕНИЯ КВАЛИФИКАЦИИ РАБОТНИКОВ НАРОДНОГО ОБРАЗОВАНИЯ. In *Профессионально-личностное развитие будущих специалистов в среде научно-образовательного кластера* (pp. 466-470).

21. Kulmatov, R., Rasulov, A., Kulmatova, D., Rozilhodjaev, B., & Groll, M. (2015). The modern problems of sustainable use and management of irrigated lands on the example of the Bukhara region (Uzbekistan). *Journal of Water Resource and Protection*, 7(12), 956.

22. Saparov, K., Rasulov, A., & Nizamov, A. (2021). Problems of regionalization of geographical names. In *ИҲҲОБАҶИИ Б ҲАҲКЕ, ОБЩЕСТВЕ, ОБРАЗОВАНИИ* (pp. 119-121).

23. Rasulov, A., Saparov, K., & Nizamov, A. (2021). THE IMPORTANCE OF THE STRATIGRAPHIC LAYER IN TOPONYMICS. *CURRENT RESEARCH JOURNAL OF PEDAGOGICS*, 2(12), 61-67.

24. Nizomov, A., Rasulov, A., Nasiba, H., & Sitora, E. (2022, December). THE SIGNIFICANCE OF MAHMUD KOSHGARI'S HERITAGE IN STUDYING CERTAIN ECONOMIC GEOGRAPHICAL CONCEPTS. In Conference Zone (pp. 704-709).

25. Rasulov, A., Alimkulov, N., & Safarov, U. (2022). THE ROLE OF GEOECOLOGICAL INDICATORS IN THE SUSTAINABLE DEVELOPMENT OF AREAS. *Journal of Pharmaceutical Negative Results*, 6498-6501.

26. Nizomov, A., & Rasulov, A. B. (2022). GEOGRAPHICAL SIGNIFICANCE OF THE SCIENTIFIC HERITAGE OF MAHMUD KASHGARI. *Journal of Geography and Natural Resources*, 2(05), 13-21.

27. Rasulov, A. (2021). The current situation in the district of lower zarafshan plant species-eco-indicator. *ASIAN JOURNAL OF MULTIDIMENSIONAL RESEARCH*, 10(4), 304-307.

28. Berdiqulov, R. S., & Yakubov, Y. Y. (2022). TALABALARGA MUSTAQIL ISH TOPSHIRIQLARINIBAJARTIRISH SHAKLI VA BAHOLASH TARTIBI. *Solution of social problems in management and economy*, 1(4), 48-55.

29. Shavkatovich, B. R. (2017). Deduction of chemical thought. *European research*, (5 (28)), 62-68.

30. [https://scholar.google.ru/citations?view\\_op=view\\_citation&hl=ru&user=mzbOeBcAAAAJ&cstart=20&pagesize=80&citation\\_for\\_view=mzbOeBcAAAAJ:dhFuZR0502QC](https://scholar.google.ru/citations?view_op=view_citation&hl=ru&user=mzbOeBcAAAAJ&cstart=20&pagesize=80&citation_for_view=mzbOeBcAAAAJ:dhFuZR0502QC).

31. [https://scholar.google.ru/citations?view\\_op=view\\_citation&hl=ru&user=mzbOeBcAAAAJ&cstart=20&pagesize=80&citation\\_for\\_view=mzbOeBcAAAAJ:4DMP91E08xMC](https://scholar.google.ru/citations?view_op=view_citation&hl=ru&user=mzbOeBcAAAAJ&cstart=20&pagesize=80&citation_for_view=mzbOeBcAAAAJ:4DMP91E08xMC)

32. [https://scholar.google.ru/citations?view\\_op=view\\_citation&hl=ru&user=mzbOeBcAAAAJ&cstart=20&pagesize=80&citation\\_for\\_view=mzbOeBcAAAAJ:FxGoFyyp5QC](https://scholar.google.ru/citations?view_op=view_citation&hl=ru&user=mzbOeBcAAAAJ&cstart=20&pagesize=80&citation_for_view=mzbOeBcAAAAJ:FxGoFyyp5QC).