



REMOVAL OF COPPER (II) AND IRON (III) MIXTURE BY PILOT NANOFILTRATION

Aoufi Boutheyna^[a] and Mohamed Amine Didi^{[a]*}

Keywords: extraction; nanofiltration; copper(II); iron(III); mixture; synergism.

In the current study, the effect of operating conditions such as pH value, feed flow, concentration of the solution and the applied pressure for the removal of copper(II), iron(III) and their mixtures for the production of drinking water by nanofiltration membrane was investigated. The results show that it is possible to extract all of the iron (III) and copper (II) at the same time to a salt mixture of Fe 50% - salt Cu 50% for concentration 4 ppm, pH = 4.5 and pressure = 6 bars. The best results for the copper(II) were obtained for the various mixtures at the pressure of 6 bars at varying pH.

*Corresponding Author

madidi13@yahoo.fr (M.A. Didi),

Tel. +213 552639237,

Fax: +213 43213198

[a] Authors Address: Laboratory of Separation and Purification Technologies, Department of Chemistry — Faculty of Sciences, Box 119, Tlemcen University — 13000, Algeria.

by using the SNTE NF270-2540. The effects of pressure and initial feed concentration on the membrane performance were studied.

Experimental

Apparatus

All chemicals used in this research were of analytical grade. All metal salt solutions were prepared by dissolving the appropriate weight of the salt of each metal in distilled water and made to a total volume of 50 L. The pH of solutions was measured using a pH-meter (Adwa), provided with a glass combine electrode. The conductivity measurements were carried by using MC126 Conductivity meter provided with an electrode.

The metal ion concentrations were determined by atomic absorption spectrophotometer (PINA cle 900 H - Perkin Elmer), using an air acetylene flame, two wavelengths were used 327.40 nm (linearity: 0.17 - 8 ppm) for copper and 302.06 nm (linearity: 0.4-20 ppm) for iron a range of standards solutions for various concentrations were prepared from a standard solution of 10 ppm for iron and 8 ppm for copper (board 1).

Pilot equipment

Filtration was performed with a tangential filtration, capacity 100 L (Figure 1). All the experiments were carried out in a closed system, where the permeate does not return to the tank whereas the retained liquid returns to the tank.

Membrane description

The module membrane spiral used was 1016 mm long and has a width of 61 mm. The nanofiltration membrane is a thin film composite membrane. All is established by three layers: A layer support in polyester (120 μm); a micro porous intercalary layer Polysulfone (40 μm) and a layer barrier (active layer) ultrathin of polyamide on the superior surface (0.2 μm).

Introduction

Heavy metals exist in the natural state in the sea water, the minerals or the volcanic compounds. A large number of techniques such as waste water treatment, adsorption, the electrolysis, the flotation, the exchanges of ions, the liquid – liquid extraction, the membrane processes etc. have been used to obtain these metals in metallic form.

Advances over the last 10 years have shown a significant growth of papers published on nanofiltration (NF) membranes in many different areas. NF membranes in contact with aqueous solution are slightly charged due to the dissociation of surface functional groups or adsorption of charge solute. These properties have allowed NF to be used in niche applications in several areas especially for water and wastewater treatment, pharmaceutical and biotechnology, and food engineering.¹ In recent years, the use of nanofiltration membranes (NF) has increased rapidly in the chemical, petrochemical, biotech and desalination industries, since the NF technology overcomes operational problems that are associated with conventional techniques. Several studies have been reported in which NF membranes have been used as tools for heavy metal removal.²

Heavy metals of the greatest concern in the treatment of waste waters are copper and iron, as they are highly toxic, non-biodegradable and have the tendency to accumulate in living organisms.³ Nanofiltration has some advantages over other membrane techniques, for example it has higher rejection of divalent ions and lower rejection of monovalent ions, lower operating pressure, higher flux and lower energy consumption compared with RO. These features recommend NF as a promising and innovative technology which can be widely applied in drinking water and the treatment of industrial effluent.⁴ The aim of this work was to study the efficiency of copper(II), iron(III) and their mixture retention

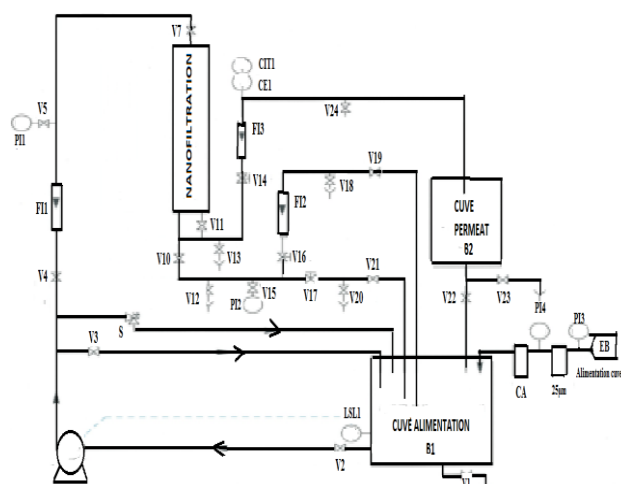

Figure 1. Schematic diagram of nanofiltration pilot.

V1: drain valve, V2: valve for alignment of the tank, V3: valve for putting in recycling, V4: valve for alignment of the circuit in entrance of membranes, V5: valve for alignment of the manometer PI1, V7: valve for alignment of nanofiltration membrane (entry), V10: valve for alignment of the membrane of nano-filtration (taking out retention), V11: valve for alignment of the membrane of nano-filtration (taking out permeate), V12: drain valve of the retentate circuit after module, V13: drain valve for the circuit of permeate after module (side sounds of conductivity), V14: valve for isolation of the circuit of permeate after module (probe conductivity), V15: valve for alignment of the manometer PI2 (taken out of module), V16: Valve for regulation of the flow of retained towards tank B1 or got out of it, V17: valve for return of the retained towards tank B1 or got out of it, V18: valve of racking of the retained, V19: valve for isolation of the circuit of return of the retained towards the tank B1, V20: valve for racking of the retained, V21: valve for isolation of the circuit for return of the retained towards the tank B1, V22: valve for return of the tank of permeate B2 towards the tank B1, V23: drain valve of the tank of permeate B2, V24: valve for taking of sample of permeate, P: high-pressure multicellular centrifugal pump, B1: tank of 100 L in PVC, B2: tank of collection of permeate of 20 L in PVC, C1: membrane of reverse osmosis (SNTE company ref XIE-2540), C2: Membrane of nano-filtration (SNTE company ref NF270-2540) THAT Filters with cartridge in the activated charcoal (SNTE company ref 25554) 25 µm filter with wound cartridge 25µm (SNTE company ref 25552), S: the safety valve of the circuit PVC, FI1: ratemeter with block 100-1000 L/h - measure of the debit of entrv, FI2: ratmeter with block 100-1000 L/h - measurement of the retentate output flow, FI3: ratemeter with block 10-100 L h⁻¹ - measure of the debit of exit of permeate, PI1, PI2 manometers 0-16 bars in entrance (entrv) and taken (brought) out of the module, PI3, PI4 manometers 0-2.5 bars for follow-up of the state of filters, I.S.I.: sounds of low level (safety (security) pumps), CE1: probe of measure of conductivity.

Extraction procedure

The experiments were carried out at the Laboratory of Separation and Purification Technologies. After each experiment the membrane is cleaned by a hydrochloric acid solution for 10 min, and then it is rinsed with distilled water.

Analytical methods

The volumetric flux was determined by measuring the permeate volume collected in given times interval. Owing to electro neutrality conditions, it was observed that both cation and anion rejection rates were the same, that is to say

$R_{\text{cation}} = R_{\text{anion}} = R$. Consequently, the rejection rate can be calculated by Eq. (1):

$$R = 100 \left(1 - \frac{C_p}{C_0} \right) \quad (1)$$

where:

C_p concentration of salt in the permeate (ppm),
 C_0 concentration of salt in the feed solution (ppm).

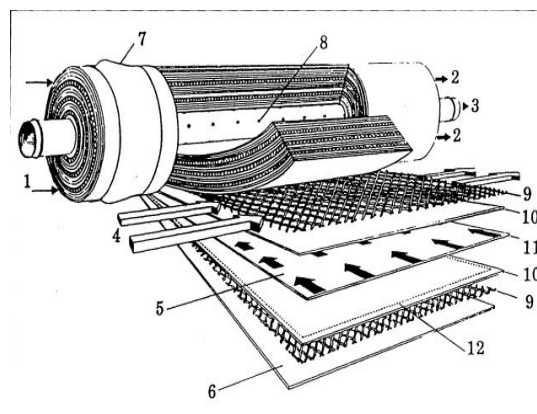

Figure 2. Membrane description.⁶

1-water inlet; 2-taken out of water; 3-taken out of permeate; 4-Smell of selling of the raw gross water; 5- Direction of permeate flow; 6- Materiel of protection; 7- Seal enters module and envelope; 8- Perforations collecting the permeate; 9-spacer; 10-membrane; 11-collector of permeate; 12- Line of weld of both membranes.

RESULTS AND DISCUSSION

Determination of the hydraulic membrane permeation

The permeability of the membrane is given by the slope of the Figure 3 which is equal with $L_p = 3.95 \text{ m s}^{-1} \text{ bar}^{-1}$ and the resistance, $R_m = 0.253 \text{ bar m}^{-1} \text{ s}$, Eqn. (2).

$$R_m = \frac{1}{A} = \frac{S \Delta P_m}{Q_p} \quad (2)$$

where :

A permeability of the membrane
 S membrane area
 ΔP_m the effective transmembrane pressure
 Q_p permeation volume flow rate.

The value of the L_p obtained on the used membrane (SNTE NF270-2540) was proved to be 1.457; 106 times as large as that obtained on the membrane Nanomax-50 (Millipore USA)⁵ and on the Duramem MWCO 900, where L_p is $0.028 \times 10^{-6} \text{ m s}^{-1} \text{ bar}^{-1}$ what shows that our membrane is very successful, and can be used in the industrial scale.

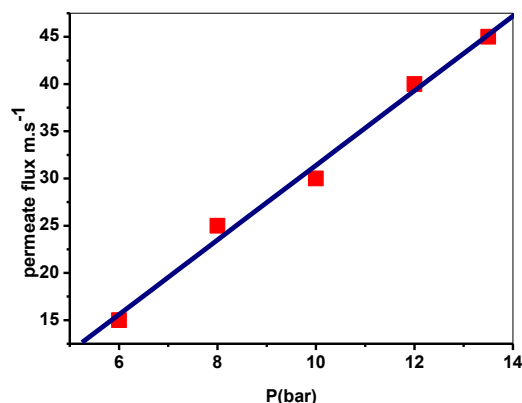

Figure 3. Permeate flux variation as a function of pressure for distilled water.

Effect of pressure and concentration for iron ion

In view of the Figure 4, we note that in the solutions containing 100 ppm and 300 ppm, the yield is 100 % for pressures varying between 6 – 13.5 bars. These results are similar to those given in the literature.^{7, 10-12} For an initial concentration of 4 ppm, the pressure has an influence; indeed for a variation of pressure of 6 - 12 bars, the yield passes from 82 % to 94 %. The pressure of 12 bars corresponds to an optimum, because beyond this pressure the retention decreases.

These results differ from the works on the nanofiltration.¹⁰ Here, the screen phenomenon was neglected because the weak concentration of the studied solution was insufficient to create this phenomenon.^{10,13} This phenomenon can be also explained differently. In the solution of concentration equal to 4 ppm, the iron ions are present in 11.4 % under the form of Fe^{3+} and 65.01 % for $\text{Fe}(\text{OH})^{2+}$ in pH 3.85 (Cheaqs Pro (Release P 2013, 1: a program for calculating of the chemical equilibria in aquatic systems, Wikovermeij, on 1999-2013). These ions characterized by small ionic ray (0.055 nm for Fe^{3+} and 0.3958 nm for $\text{Fe}(\text{OH})^{2+}$) can enter into the pores of the membrane (diameter of pores = 1 nm) where they are partially retained by the membrane surface forces (electrostatics and friction forces).^{8, 9, 13} When the pressure increases the surface forces remain constant, whereas the sweeping forces increase due to flux in the pores.

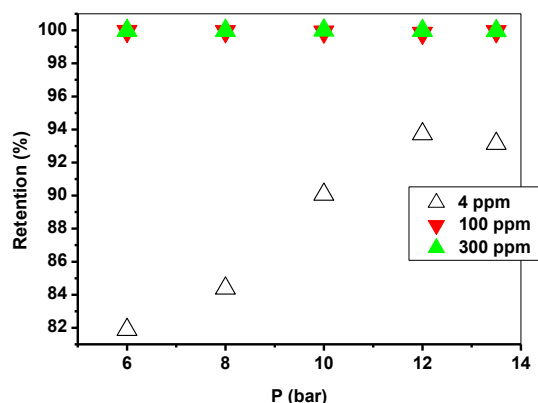

Figure 4. Variation of iron retention as a function of the pressure for different concentrations.

In view of the Figure 5, no gap was observed between the results regarding water and those corresponding to the solution of 4 ppm for pressures varying of 6 bars to 13.5 bars. This shows that the iron cations are not rejected of the surface of the membrane. For the solutions to 100 ppm and 300 ppm, the gaps regard to the water become important; about or admitted pressure the iron ions are rejected farther from the surface of the membrane. This effect makes the concentration gradient weak for 4 ppm, and consequently it results by a weak difference in osmotic pressure with having a consequence of maintaining of effective pressure.^{10, 12} At concentrations higher (100 ppm and 300 ppm), the gap increases on concentration in iron because of the polarization.^{7,10}

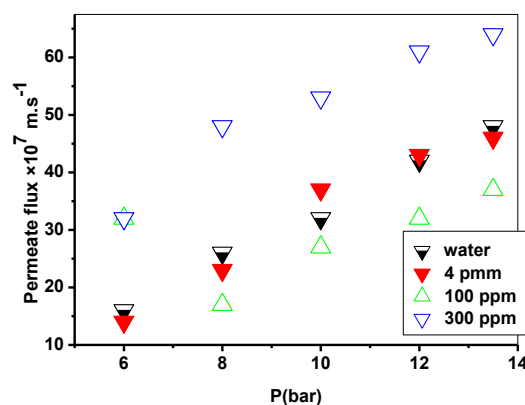

Figure 5. Variation of flux of permeate and the flux of water according to the pressure for different iron concentration.

Effect of pressure and concentration for copper ion

In view of the Figure 6, we note that for an initial concentration of 4 ppm, the pressure influence is not neglected on the yield of extraction, because for a variation of pressure from 6 - 10 bars, the yield passes from 92 % to 94 %. The pressure of 10 bars corresponds to an optimum, because beyond this pressure the retention decreases. We notice that for the solution containing 100 ppm, the yield varies from 80 % - 82 %, for pressures which vary between 6 - 13.5 bars. For the solution containing 300 ppm, the yield passes from 82 % - 84 %. The pressure of 12 bars corresponds to an optimum, because beyond this pressure the retention decreases. These results are not similar to those obtained in other works.^{7,10-12} Here, the screen phenomenon was neglected because the weak concentration of the studied solution was insufficient to create this phenomenon.^{10,13} This phenomenon can be also explained differently. In the solution of concentration equal to 4 ppm, the copper ions are present in 70.57 % under the form Cu^{2+} and 22.02 % for a pH=7.4 (Cheaqs Pro (Release P 2013, 1: a program of calculation of the chemical equilibria in aquatic systems, Wikovermeij, on 1999-2013). These ions characterized by a small ionic ray (0.073nm for Cu^{2+}) can penetrate in the pores of the membrane (diameter of pores = 1 nm), where they are partially retained by the membrane surface forces (electrostatic and friction forces).^{8,9,13} When the pressure increases, the surface forces remain constant whereas the sweeping forces due to flux in pores increases.

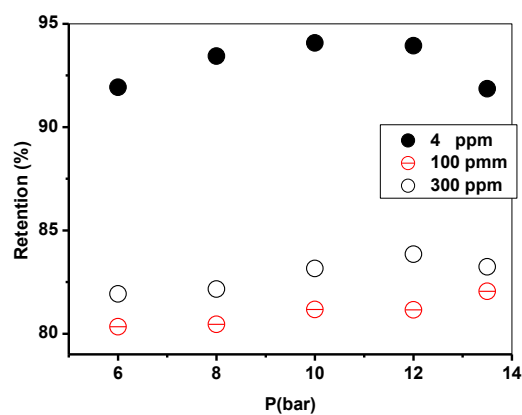

Figure 6. Variation of copper retention as a function of the pressure for different concentrations

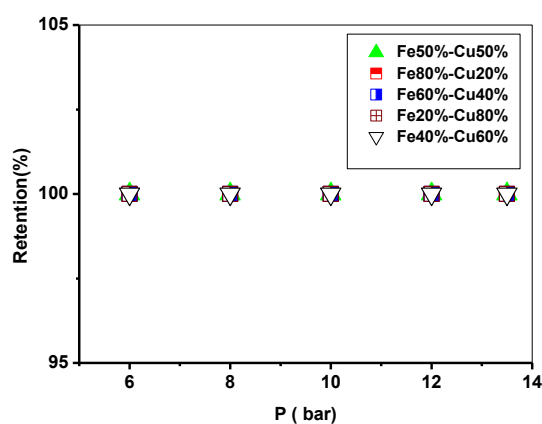

Figure 8. Variation of iron retention as a function of the pressure for different mixtures

In view of the Figure 7, contrary to the iron, a small gap was observed between the results regarding water and those corresponding to the solutions of 4 ppm. This could be explained by a weak rejection of the copper ions farther from the membrane surface. This effect makes the concentration gradient weak, and consequently it results in a weak difference in osmotic pressure and to have consequently the effective preservation of the pressure. 10,12 Between 8-12 bars and in higher concentrations (100 ppm and 300 ppm), there is no gap between flows, but the gradient of concentration increases because of the of the polarization. 7,10

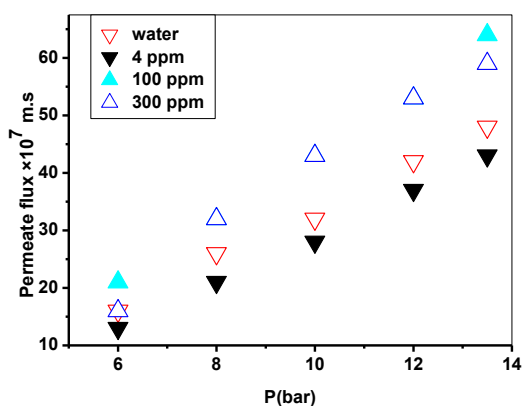

Figure 7. Variation of flux of permeate and the flux of water according to the pressure for different copper concentration.

Effect of pressure and concentration for mixtures

Effect of pressure and concentration for iron

Figure 8 shows that, for variations of pressure from 6 - 13.5 bars, the retention is quantitative (100 %) for iron and copper at different proportions, while maintaining a total concentration of 4 ppm for the mixture. A pressure of 6 bars is enough for a full purification of iron. The difference between the iron and the copper is not observable, because the presence of the copper in the mixture does not influence the retention of the iron.

Effect of pressure and concentration for copper

The presence of iron influences the retention of the copper as seen from the results presented in Figure 9. The best retentions were obtained for the mixture Fe 60 % + Cu 40 % about pressure from 12 bars. For the mixture Fe 80 % + Cu 20 %, pressure up to 10 bars, the retention is constant (around 74 %) then increases exponentially until 97 % beyond this pressure. The effect of pressure was important on the retention, whatever the proportions of the mixture; the total concentration being always maintained at 4 ppm.

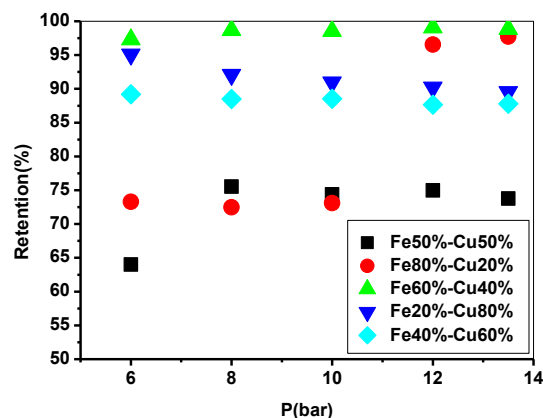

Figure 9. Variation of copper retention as a function of the pressure for different mixtures.

Effect of pH for the retention of iron and copper in the mixture iron salt 50% - copper salt 50%

In view of the Figure 10 (A), the obtained results show that the accepted pressure is about (6 - 13.5 bars) and the pH = 6.8; the retention of the iron is total (100 %). With pressure 6 bars, the retention of the iron is also total, in pH = 4.5. The difference at pH=6.8 and pH=3.7 then 5.5 becomes important. The best conditions of extraction of the iron correspond to pH = 4.5 and the pressure of 6 bars, with the addition of some mL of HCl. Without the addition of HCl, the best conditions are pH = 6.8 and the pressure of 6 bars

For pH 3.7, 4.5 and 5.5, the retention of the iron at the pressure of 13.5 bars is almost the same (78 %) We can conclude that there is an interaction between these two parameters. A study of plan of experience would allow quantifying this interaction. The purification is total for the mixture in the pressure of 6 bars and in pH = 4.5. Whereas the best selectivity is obtained for a pH = 6.8 (without addition of HCl) and the accepted pressure of 6 bars.

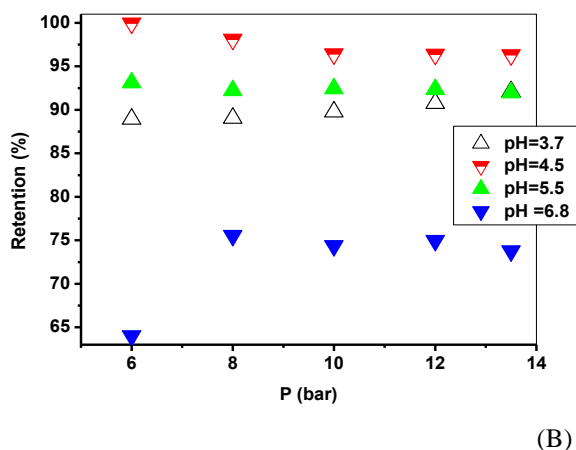
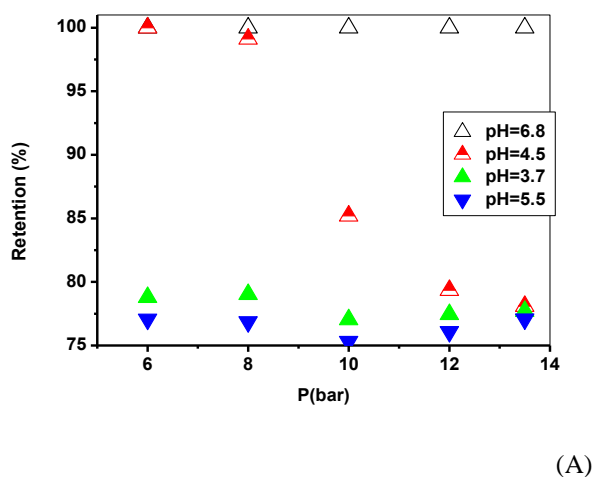

Figure 10. Variation of iron (A) and copper (B) retention as a function of the pressure for mixture salt iron 50%-salt copper 50%

Effect of pH for the retention of iron and copper in the mixture iron salt 80%-copper salt 20%

In view of the figure 11 (A), the obtained results show that the retention of iron is total (100 %) at pressure 6 - 13.5 bars and pH 3.3 - 7.5. In view of the figure 11 (B), for pH 3.3; 4.5 and 5.5 (with the addition of some mL of HCl) and a pressure from 6 - 13.5 bars the retention of copper is total (100 %).

The membrane extracts the mixture without distinction between the iron and the copper, although these two metals have different physical-chemical properties; the iron Macke left some ferromagnetic metals. The best selectivity is obtained for a pH = 7.5 (without addition of HCl) and the accepted pressure of 8 bars.

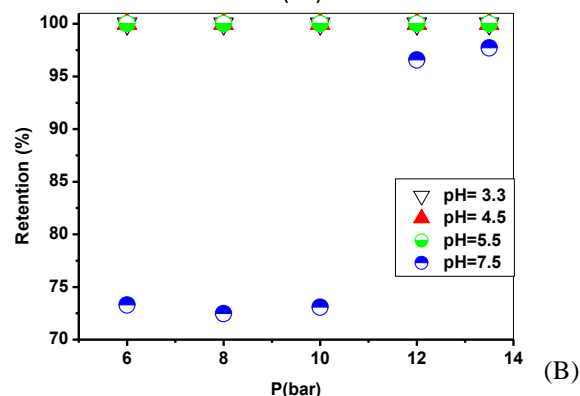
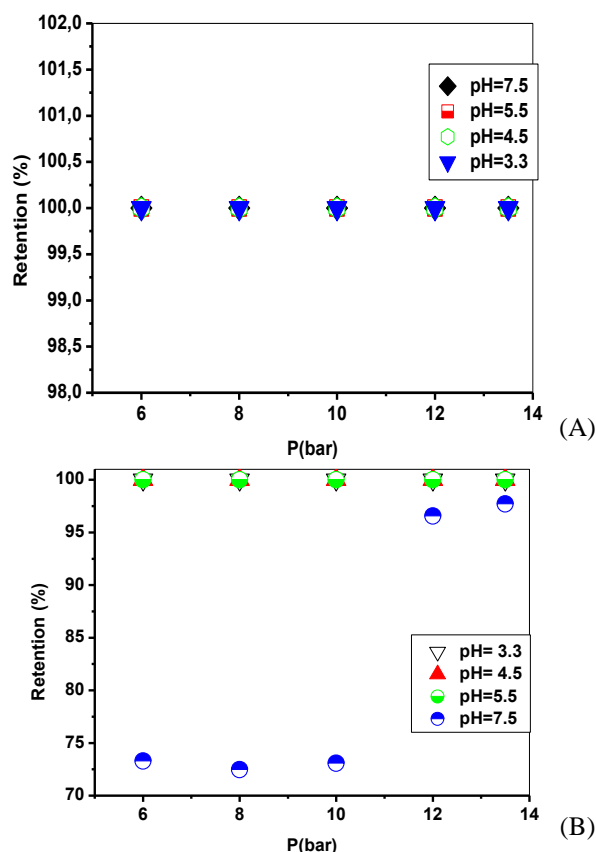

Figure 11. Variation of iron (A) and copper (B) retention as a function of the pressure for mixture salt iron 80%-salt copper 20%

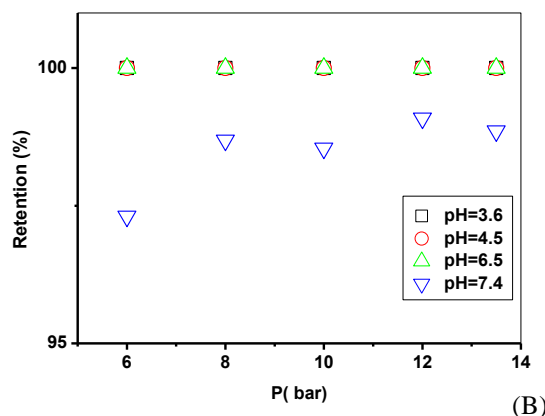
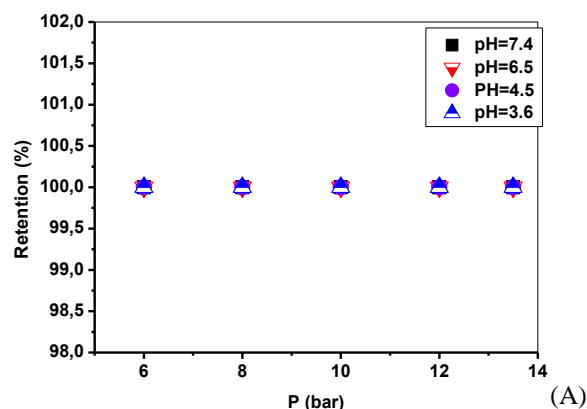

Figure 12. Variation of iron (A) and copper (B) retention as a function of the pressure for mixture salt iron 60% - salt copper 40%.

Effect of pH for the retention of iron and copper in the mixture iron salt 60%-copper salt 40%

In view of the Figure 12 (A), the obtained results show that the retention of the iron is total (100%) at pressures from 6 to 13.5 bars, and pH from 3.6 to 7.4. In view of the Figure 14 (B), pH 3.6, 4.5, and 6.5 (with the addition of some mL of HCl) and a pressure from 6 to 13.5 bars the retention of the copper is total (100%). The separation takes place at P = 6 bars and pH = 7.4 which is a neutral pH. On these conditions of separation the speeds of diffusion through the membrane have different values.

Effect of pH for the retention of iron and copper in the mixture iron salt 20%-copper salt 80%.

In view of the Figure 13(A), the results show that at pressures from 6 to 13.5 bars and pH from 3.7 to 6.4, the retention of the iron is total (100%). In view of the figure 13(B), for pH 3.7, 4.9, and 5.4 (with the addition of some ml of HCl) and at pressures from 6 to 13.5 bars the retention of the copper is total (100 %). In these pH, the process does not make a difference between the iron and the copper. In pH = 6.4 and at P =13.5 bars, the separation between both metals is the most important. The retention decreases at pH = 6.4 with the increase of the pressure.

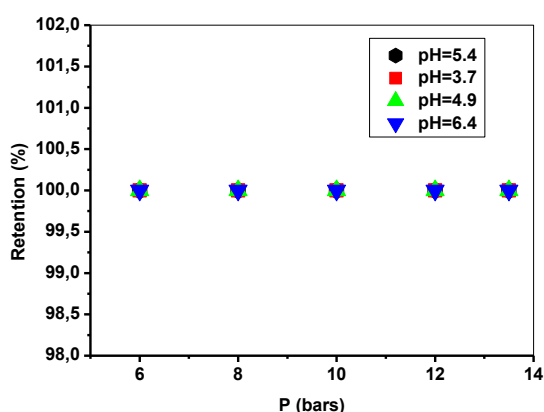

(A)

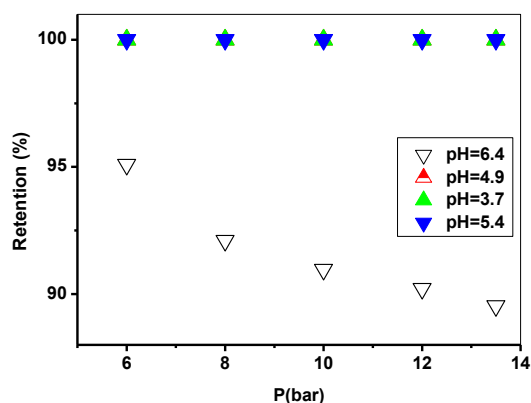

(B)

Figure 13. Variation of iron (A) and copper (B) retention as a function of the pressure for mixture salt iron 20%-salt copper 80%.

Effect of pH for the retention of iron and copper in the mixture iron salt 40%-copper salt 60%

In view of the Figure 14(A), the results show that the retention of the iron is total (100%) at pressure from 6 to 13.5 bars and at pH from 3.7 to 6.8.

In view of the Figure 14(B), the retention of the copper is total (100 %) for pH 3.7, 4.5, (with the addition of some ml of HCl) and 6.8 (with the addition of some ml of NaOH) at pressures from 6 to 13.5 bars. The difference of retention is obtained at pH = 5.8. In this pH, the effect of increase in pressure on the retention was weak.

Effect of pH for the retention of copper

The retention is minimal at pH 6.7 and at pressure from 8 bars. In pH = 6.7 the charge loss is important. It makes an effect of the screen on the membrane surface, so preventing it from making cross the copper.

Na^+ added, can enter it competitions with the copper (II). For three other pH, the influence of the pressure is small. However the retention contrary to the iron does not affect the 100 %.

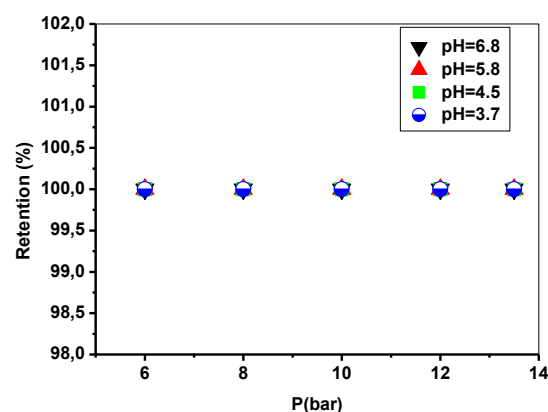

(A)

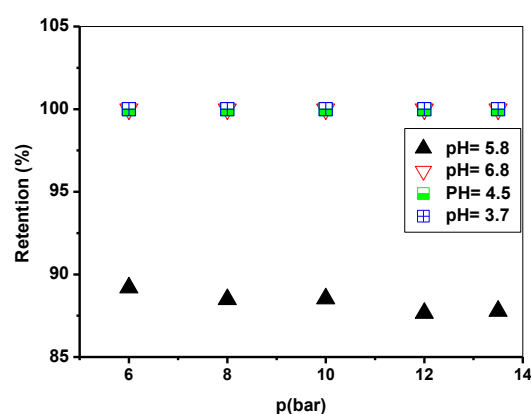

(B)

Figure 14. Variation of iron (A) and copper (B) retention as a function of the pressure for mixture salt iron 40%-salt copper 60%.

Table 1. Effect of copper in the mixture ($C_{P_s} = 0.22$ ppm)

| Mixture | $C_{P,m}$ | $C_{P,m}/C_{P,s}$ | Effect |
|-------------------------------|-----------|-------------------|------------|
| Salt of Fe 50%-salt of Cu 50% | 0.95 | 4.32 | synergism |
| Salt of Fe 80%-salt of Cu 20% | 0.07 | 0.32 | antagonism |
| Salt of Fe 60%-salt of Cu 40% | 0.03 | 0.14 | antagonism |
| Salt of Fe 20%-salt of Cu 80% | 0.19 | 0.86 | antagonism |
| Salt of Fe 40%-salt of Cu 60% | 0.40 | 1.82 | synergism |

Table 2: Effect of iron in the mixture ($C_{P_s} = 0.21$ ppm)

| Mixture | $C_{P,m}$ | $C_{P,m}/C_{P,s}$ | Effect |
|---------------------------------|-----------|-------------------|------------|
| Ssalt of Fe 50%- salt of Cu 50% | 0.00 | 0.00 | antagonism |
| Salt of Fe 80%- salt of Cu 20% | 0.00 | 0.00 | antagonism |
| Salt of Fe 60%- salt of Cu 40% | 0.00 | 0.00 | antagonism |
| Salt of Fe 20%- salt of Cu 80% | 0.00 | 0.00 | antagonism |
| Salt of Fe 40%- salt of Cu 60% | 0.00 | 0.00 | antagonism |

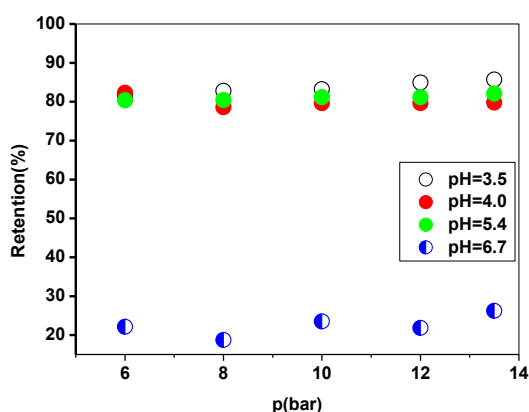
**Figure 15.** Variation for the retention of copper as a function of the pressure.

Effect of pH for the retention of iron

Within 1%; Independently of the pH, the retention was total; whatever the admissible pressure is total. Nanofiltration is better suited for iron than copper.

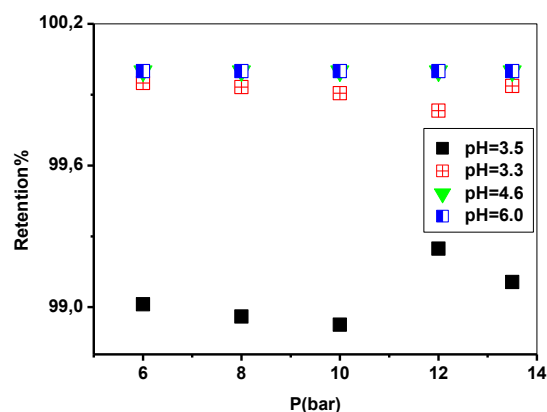
**Figure 16.** Variation for the retention of iron as a function of the pressure.

Effect of synergism.

The numerical value of $C_{P,m}/C_{P,s}$ ratio gives information about presence/absence of synergism or antagonism. If $C_{P,m}/C_{P,s} > 1$, synergism takes place (the effect of the mixture is greater each of the ion in the mixture). If $C_{P,m}/C_{P,s} < 1$, antagonism is occurred (the effect of the mixture is less than that each of the ion in the mixture). If $C_{P,m}/C_{P,s} = 1$, there is no **interaction** (interaction the mixture has no effect on the adsorption of each of the adsorbates in the mixture).^{14,15}

Several factors are considered to correlate metal ion uptake and metal ion properties. Factors like electronegativity of the metal ion, electrostatic attraction due to charge to radius ratio, ability to form metal hydroxide complex and suitable site for adsorption on adsorbent are responsible for competitive adsorption of one metal ion over another.^{10,11}

Conclusion

The retention of a species in nanofiltration is done as a function of the ionic and steric exclusion which it undergoes. The charge of ions (sign and valence), compared with the sign of the active groups of the membrane (polyamide), is an element prevailing in the retention of the ion. The bivalent co-ion (Cu^{2+}) or trivalent (Fe^{3+}) is strongly retained and against monovalent ion (NO_3^-), by its presence to the membrane, may do a screen effect partially by the residual ionized groups of the membrane until invert the sign of its potential. The monovalent co-ions (Na^+) cross all the better the membrane than their Ionic mobility is stronger and than the number of groups ionized by the membrane is low. The strong retention of a co-ion Bivalent or trivalent inferred also a superior transmission in co-ions and against monovalent ions, so as to compensate for the led_(inferred) imbalance of load_(responsibility).

During the term of this study, the consideration of the difference ($\text{pH}_r - \text{pH}_n$), the retention of H^+ or of OH^- according to its sign, establishes a good descriptor of the imbalance of Ionic partitions realized between the solution and the pores of the membrane.

The mechanisms of transfer of ions to be proposed in this study should allow a better understanding the selectivity observed during the nanofiltration.

Symbols

| | |
|-----------------|---|
| pH_r | pH of permeate |
| pH_n | pH of retentate. |
| C_{Pm} | concentration of an ion in the mixture (Fe^{3+} , Cu^{2+}). |
| C_{PS} | concentration of a single ion in solution. |

Acknowledgements

We gratefully acknowledge the ATRST-Algeria (ex. ANDRU) for their financial support.

Conflict of Interest

The authors declare that they have no conflict of interest.

References

- Mohammad, A. W., Teow, Y. H., Ang, W. L., Chung, Y. T., Oatley-Radcliffe, D.L., Hilal, N., *Desalination*, **2015**, 356, 226.
- Al-Rashdi, B., Somerfield, C., Hilal, N., *Sep. Purif. Rev.*, **2011**, 40, 209.
- Gherasim, C. V., Mikulášek, P., *Desalination*, **2015**, 343, 67.
- Mulder, M., *Basic Principles of Membrane Technology*, Kluwer Academic Publisher, Dordrecht, **1996**.
- Belkhouche, N., Didi, M. A., Taha, S., Benfarès, N., *Desalination*, **2009**, 239, 58.
- Tsibranska, I., Saykova, I., *J. Chem. Technol. Met.*, **2013**, 48, 333.
- González-Muñoz, M.J., Rodríguez, M.A., Luque, S., Álvarez, J.R., *Desalination*, **2006**, 200, 742.
- Artu, G., Hapke, J., *Desalination*, **2006**, 200, 178.
- Fatin-Rouge, N., Szymczyk, A., Ozdemir, E., Vidonne, A., Fievet, P., *Desalination*, **2006**, 200, 133.
- Ben Frarès, N., Taha, S., Dorange, G., *Desalination*, **2005**, 185, 245.
- Pontié, M., Lhassani, A., Diawara, C.K., Elana, A., Innocent, C., Aureau, D., Rumeau, M., Croue, J.P., Buisson, H., Hemery, P., *Desalination*, **2004**, 167, 347.
- Paugam, L., Taha, S., Carbon, J., Gondrexon, N., Dorange G., *Rev. Sci. Eau.*, **2001**, 14, 511.
- Szymczyk, A., Fievet, P., Ramseyer, C., *Desalination*, **2006**, 200, 125.
- Roy, A., Bhattacharya, J., *Sep. Purif. Technol.*, **2013**, 115, 172.
- Mahamadi, C., Nharingo, T., *Bioresour. Technol.*, **2010**, 101, 859.
- Bulletin technique, Pilote d'osmose inverse et de nanofiltration*, MP72 / N°24.

Received: 08.01.2017.
Accepted: 12.02.2017.